

VFLAH 155

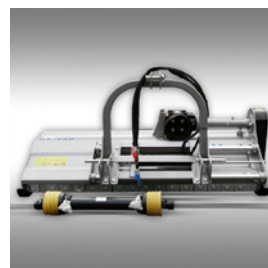







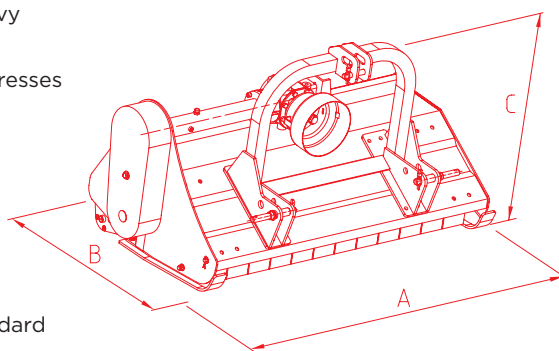

LONGREACH
EQUIPMENT



- Heavy duty model for medium plus hp class tractors
- 3 belt “b” section drive
- Rear door for ease of maintenance and heavy mowing ejection
- Free wheel gearbox to minimize gearbox stresses
- Heavy duty self-centering bearings
- Best quality general-purpose machine
- Hydraulic offset standard
- Rear roller and adjustable skids
- Ideal in narrow vineyard rows
- Manufactured to the highest European standard
- 2 year full factory warranty. Full spare parts availability.



														A	B	C	
cm	min	max	cm	n°	n°	n°	rpm	cm	cm	cm	kgs						
155	30	70	45+115 80+75	24	48	3	540	167	95	95	330						

PRICE